

8-1-2007

A Methodology to Predict the Effects of Quench Rates on Mechanical Properties of Cast Aluminum Alloys

Shuhui Ma

Mohammed D. Maniruzzaman

D. S. Mackenzie

Richard D. Sisson Jr.

Worcester Polytechnic Institute, sisson@wpi.edu

Follow this and additional works at: <https://digitalcommons.wpi.edu/mechanicalengineering-pubs>



Part of the [Mechanical Engineering Commons](#)

Suggested Citation

Ma, Shuhui , Maniruzzaman, Mohammed D. , Mackenzie, D. S. , Sisson, Richard D. (2007). A Methodology to Predict the Effects of Quench Rates on Mechanical Properties of Cast Aluminum Alloys. *Metallurgical and Materials Transactions B-Process Metallurgy and Materials Processing Science*, 38(4), 583-589.

Retrieved from: <https://digitalcommons.wpi.edu/mechanicalengineering-pubs/55>

This Article is brought to you for free and open access by the Department of Mechanical Engineering at Digital WPI. It has been accepted for inclusion in Mechanical Engineering Faculty Publications by an authorized administrator of Digital WPI. For more information, please contact digitalwpi@wpi.edu.

A Methodology to Predict the Effects of Quench Rates on Mechanical Properties of Cast Aluminum Alloys

SHUHUI MA, M.D. MANIRUZZAMAN, D.S. MACKENZIE, and R.D. SISSON, Jr.

The mechanical properties of age-hardenable Al-Si-Mg alloys depend on the rate at which the alloys are cooled after the solutionizing heat treatment. Quench factor analysis, developed by Evancho and Staley, was able to quantify the effects of quenching rates on the as-aged properties of an aluminum alloy. This method has been previously used to successfully predict yield strength and hardness of wrought aluminum alloys. However, the quench factor data for aluminum castings is still rare in the literature. In this study, the time-temperature during cooling and hardness were used as the inputs for quench factor modeling. The experimental data were collected using the Jominy end quench method. Multiple linear regression analysis was performed on the experimental data to estimate the kinetic parameters during quenching. Time-temperature-property curves of cast aluminum alloy A356 were generated using the estimated kinetic parameters. Experimental verification was performed on a cast engine head. The predicted hardness agreed well with that experimentally measured. The methodology described in this article requires little experimental effort and can also be used to experimentally estimate the kinetic parameters during quenching for other aluminum alloys.

DOI: 10.1007/s11663-007-9044-3

© The Minerals, Metals & Materials Society and ASM International 2007

I. INTRODUCTION

THE heat treatment of aluminum alloys usually involves three steps: solutionizing, quenching, and aging. Depending on the cooling rate in the quenching process, precipitates can heterogeneously nucleate at the grain or phase boundaries or at any available defects present in the α -aluminum matrix. This kind of precipitation can result in reduction of supersaturation of the solid solution, which decreases the ability of the alloy to develop the maximum properties attainable with the subsequent aging treatment. A quantitative measurement of the properties resulting from different cooling rates is needed for the quenching process design.^[1] Quench factor analysis, developed by Evancho and Staley, was able to quantify the variation in properties due to different cooling rates.^[1]

Quench factor analysis has been applied to a wide range of wrought aluminum alloys to predict properties or to optimize industrial quenching procedures.^[2-5] It is now recognized as an important technique for modeling property variation during continuous cooling. In order to use quench factor analysis for property prediction, the kinetic parameters of an aluminum alloy during quenching need to be experimentally estimated and verified. Interrupted quench, developed by Fink and Willey,^[6] was traditionally employed by the researchers to collect the experimental data including the thermal history of an alloy being studied and mechanical properties from the corresponding quenching process. Using the interrupted quench technique, Dolan *et al.* determined the kinetic parameters for 7175-T73 based on hardness, electrical conductivity, and tensile strength.^[7,8] Staley gave an example of using the quench factor analysis method to design an extrusion quench system that could be used to quench extruded shapes of AA 6061 as the materials left the die.^[9] Bernardin and Mudawar^[10] generated the C-curve for wrought aluminum alloy 2024 with the delayed quench technique in terms of Rockwell hardness in B scale.

The interrupted quench technique requires tedious experimental work; however, the application of the Jominy end quench method for the quench factor analysis has been successfully developed and used by MacKenzie and Newkirk to estimate the kinetic parameters of wrought aluminum alloys 7075 and 7050.^[4,5] The Jominy end quench method was originally developed to determine the hardenability of steels,^[11,12] but now it has been widely applied to obtain an enhanced insight into nonferrous alloys^[13-16] because it can provide multiple sets of cooling curves with only one quench.

There are a variety of ways to obtain C-curves and kinetic parameters with the experimentally measured

SHUHUI MA, formerly with the Center for Heat Treating Excellence, Materials Science and Engineering, Worcester Polytechnic Institute, Worcester, MA 01609, is a New Product Development Engineer at Tiffany & Company, Cumberland, RI, USA 02864. Contact e-mail: shuhui.ma@gmail.com M.D. MANIRUZZAMAN, Research Assistant Professor, the Center for Heat Treating Excellence, Materials Science and Engineering, Worcester Polytechnic Institute, Worcester, MA, USA 01609. Contact e-mail: maniruzzaman@wpi.edu R.D. SISSON, Jr., Professor and Director of Manufacturing and Materials Science & Engineering Programs, the Center for Heat Treating Excellence, Materials Science and Engineering, Worcester Polytechnic Institute, Worcester, MA, USA 01609. D.S. MACKENZIE is with the Houghton International, Valley Forge, PA, USA.

This article is based on a presentation made in the symposium "Simulation of Aluminum Shape Casting Processing: From Design to Mechanical Properties" which occurred March 12-16, 2006, during the TMS Spring meeting in San Antonio, Texas, under the auspices of the Computational Materials Science and Engineering Committee, the Process Modeling, Analysis and Control Committee, the Solidification Committee, the Mechanical Behavior of Materials Committee, and the Light Metal Division/Aluminum Committee.

properties and cooling data. The C-curves of 7175-T73 were generated by Dolan *et al.* using the least-squares best fit method, and the constants K_2 to K_5 were estimated with nonlinear regression analysis.^[7] Flynn and Robinson determined the kinetic parameters K_2 to K_5 for aluminum 7010 using multiple regression analysis.^[17] Staley estimated the kinetic parameters of AA6061 with the least-squares routine.^[9] MacKenzie and Newkirk^[4,5] generated the C-curves of 7075 and 7050 by simultaneously solving a series of nonlinear equations, and the kinetic parameters were estimated by fitting the generated C-curve with the nonlinear least-squares routine.

However, the methodology for generating C-curves and kinetic parameters for cast aluminum alloys during quenching is not available in the literature. In this study, the experimental data were collected from the Jominy end quench tests.^[4,5] Although generating C-curves by solving a series of nonlinear equations and estimating K constants with the nonlinear least-squares routine by MacKenzie and Newkirk have been successful,^[4,5] this article used multiple linear regression analysis^[18] to estimate kinetic parameters during cooling for cast aluminum alloy A356 with the experimentally collected data. The results were verified on a cast engine head.^[19] The methodology described in this article requires little experimental effort and can be used for estimating kinetic parameters of other aluminum alloys, either cast or wrought.

II. THE MATHEMATICAL MODEL

Quench factor analysis is a tool for predicting mechanical properties of an alloy with a known quench path and the precipitation kinetics described by time-temperature-property (TTP) curves. The TTP curve in

Figure 1 is a graphical representation of the transformation kinetics that influences such properties as hardness or strength.^[2] The assumptions behind quench factor analysis include that the precipitation reaction during quenching is additive and the reduction in strength can be related to the reduction of supersaturation of solid solution during quenching.^[9]

The quench factor is typically calculated from a cooling curve and a C_T function, an equation that describes the transformation kinetics of an alloy. Evancho and Staley^[9] defined the C_T function as having a form similar to the reciprocal of the classical nucleation rate equation. This form can be expressed using the following equation:^[1,2,4,5,9]

$$C_T = -K_1 * K_2 * \exp \left[\frac{K_3 * K_4^2}{RT(K_4 - T)^2} \right] * \exp \left[\frac{K_5}{RT} \right] \quad [1]$$

where C_T is the critical time required to form a specific percentage of a new phase; K_1 is a constant, which equals the natural logarithm of the fraction untransformed during quenching (typically 99.5 pct: $\ln(0.995) = -0.00501$); K_2 is a constant related to the reciprocal of the number of nucleation sites; K_3 is a constant related to the energy required to form a nucleus; K_4 is a constant related to the solvus temperature; K_5 is a constant related to the activation energy for diffusion; R is the universal gas constant, 8.3144 J/K* mol ; and T is the absolute temperature (K).

The incremental quench factor, q_j , represents the ratio of the amount of time the alloy is at a particular temperature divided by the time required for a specific percentage of transformation.^[2] Incremental quench factors can be calculated at each temperature and summed up over the entire transformation range to produce the cumulative quench factor Q .^[1,5,9]

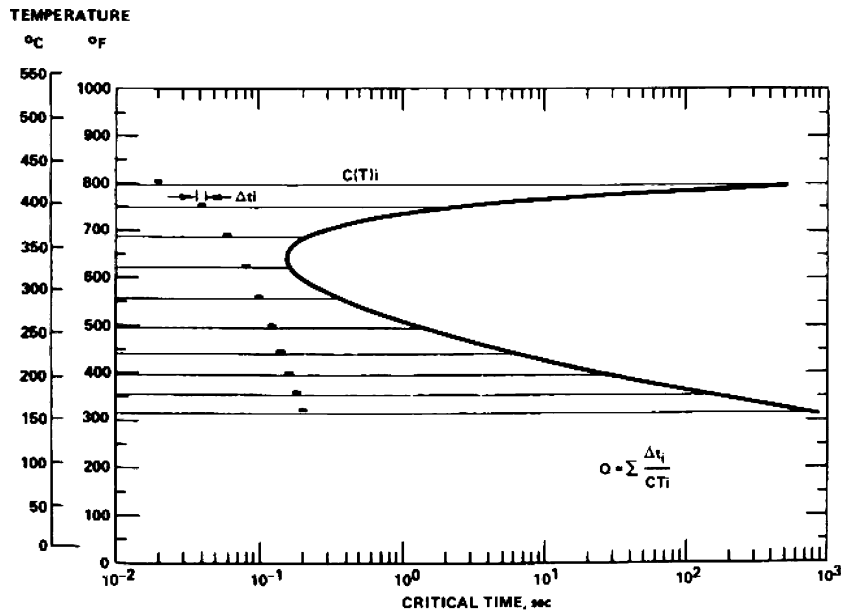

Fig. 1—Schematic illustrations on the plot of C_T function to calculate the quench factor.

$$Q = \sum q_f = \sum_{T_1}^{T_2} \frac{\Delta t_i}{C_{Ti}} \quad [2]$$

where q_f is the incremental quench factor and Δt_i is the time elapsed at a specific temperature.

With the calculated quench factor, Q , the strength can be predicted using the following classical quench factor model:^[3,9]

$$\frac{\sigma - \sigma_{\min}}{\sigma_{\max} - \sigma_{\min}} = \exp (K_1 Q)^n \quad [3]$$

where σ is the strength; σ_{\max} and σ_{\min} are the maximum and minimum strength attainable for a specific alloy, respectively; K_1 is decided previously; and n is the Avrami exponent.

Based on the original quench factor model shown in Eq. [3], improvements have been made to justify assumptions used for quench factor analysis, including the relationship between strength and solute concentration, minimum strength, and Avrami exponent.^[20] The assumption of the linear relationship between strength and retained solute concentration was found to contradict the strengthening theory. According to the strengthening theory, Eq. [3] is rewritten as the following improved formula:^[20]

$$\frac{\sigma - \sigma_{\min}}{\sigma_{\max} - \sigma_{\min}} = [\exp (K_1 Q)^n]^{1/2} \quad [4]$$

A variety of mechanical properties have been used for quench factor modeling, including Vickers hardness,^[4,5,7,20] Rockwell hardness,^[2,10] electrical conductivity,^[7,17] yield strength,^[3,20,21] and tensile strength.^[7] Although many successful predictions were made in the literature, the classical quench factor models were established based on the variation of strength with the retained solute concentration. Caution has to be taken when any properties other than strength are used in the quench factor modeling unless a linear relationship between the strength and the property exists for the alloy being studied.^[20] In this investigation, the Meyer hardness, \bar{P} , is the property used in the quench factor modeling, which has an approximately linear relationship with strength. The Meyer hardness is defined as^[22]

$$\bar{P} = \frac{4L}{\pi d^2} \quad [5]$$

where \bar{P} is the Meyer hardness, MPa; L is the load, kg; d is the diameter of indentation, mm.

The relationship between Rockwell hardness and Meyer hardness can be experimentally determined for an alloy. For cast aluminum alloy A356, the conversion was established by Tiryakioglu and Campbell using regression analysis of the experimental data.^[22] The indentation size, d , is correlated with the Rockwell B hardness in the following equation:^[22]

$$d = 1.263 - 5.270 \times 10^{-3} \text{RHB} \quad [6]$$

Using Eqs. [5] and [6], the Meyer hardness can be calculated from the experimentally measured Rockwell

hardness in B scale. The reason of using the Meyer hardness in the quench factor modeling is that it has a linear relationship with strength so the assumptions for quench factor models are still valid in this case.

III. RESEARCH METHODOLOGY

The research methodology used in this article for estimating kinetic parameters of aluminum alloys during quenching is illustrated in Figure 2. This methodology starts from preparing an aluminum alloy of interest and casting Jominy end quench bars. Based on the ASTM standard A255, Jominy end quench tests are performed to experimentally collect time-temperature and Rockwell hardness data at a series of selected locations on a bar. The advantage of using the Jominy end quench method for quench factor modeling is that a large range of cooling rates can be obtained with only one quench, which dramatically reduces the experimental efforts that are usually required with any other method. Rockwell hardness is converted to the Meyer hardness using the relationship established by Tiryakioglu and Campbell, as shown in Eqs. [5] and [6].^[22] Multiple linear regression analysis is performed on the experimental data to numerically estimate the kinetic parameters. These kinetic parameters are experimentally verified on a cast engine cylinder head. This methodology requires little experimental effort, is illustrated for cast aluminum alloy A356, and can be used to experimentally estimate kinetic parameters during quenching for other heat-treatable aluminum alloys. More detailed procedures of this methodology are included in Section IV.

IV. EXPERIMENTAL

A. Materials and Sample Preparation

Aluminum A356 cylindrical bars, 2.54 cm in diameter and 20.32 cm in length, were cast in a permanent cast

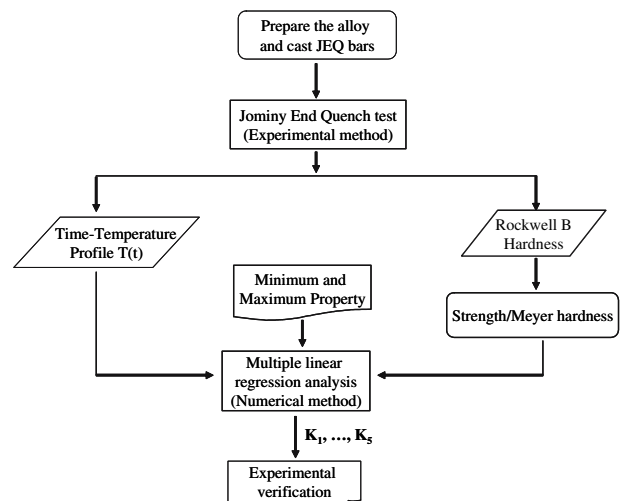

Fig. 2—Overview of the research methodology for quench factor analysis.

iron mold in the WPI Metal Processing Institute Advanced Casting Laboratory. The casting mold was preheated to 427 °C in a GECO BHT30 furnace. Aluminum alloy A356 ingots were melted in a MELLEN CC12 resistance furnace and cast into the preheated cast iron mold. Prior to casting, the melt was degassed using argon gas for about 90 minutes. A rotary impeller was used to agitate the melt during degassing. The melt pouring temperature was kept constant at 800 °C in the furnace. Jominy end quench specimens (2.54 cm in diameter, 10.16 cm in length) were fabricated from cast bars according to SAE J406 and ASTM A255 standards. The chemical composition of cast aluminum alloy A356 used in this study is given in Table I. This alloy is modified with 0.02 pct strontium.

B. Experimental Apparatus

The Jominy end quench apparatus was built according to the standard described in the SAE J406 and ASTM A255 specifications. A schematic of the apparatus is shown in Figure 3. An orifice, 12.7 mm in diameter, is connected to the waterline through a plastic pipe for quenching. The top plate supports the part in position. According to the standards, the distance between the test specimen and the orifice is 12.7 mm. Because the quenching occurs at one end of a bar, the cooling along an entire Jominy end quench bar is one-dimensional.

V. RESULTS AND DISCUSSION

A. Microstructure of Cast Aluminum Alloy A356

The microstructure of as-cast and as-solutionized cast aluminum alloy A356 was examined with both scanning

Table I. Chemical Composition of Cast Aluminum Alloy A356 (Weight Percent)

Si	Mg	Cu	Mn	Fe	Zn	Ti	Sr	Al
7.20	0.35	0.01	0.0026	0.125	0.01	0.13	0.02	balance

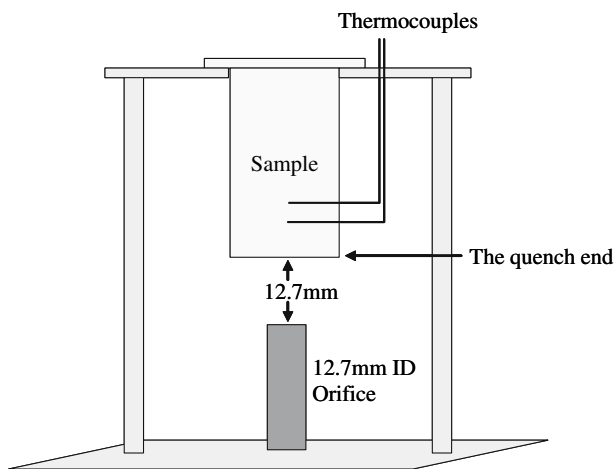
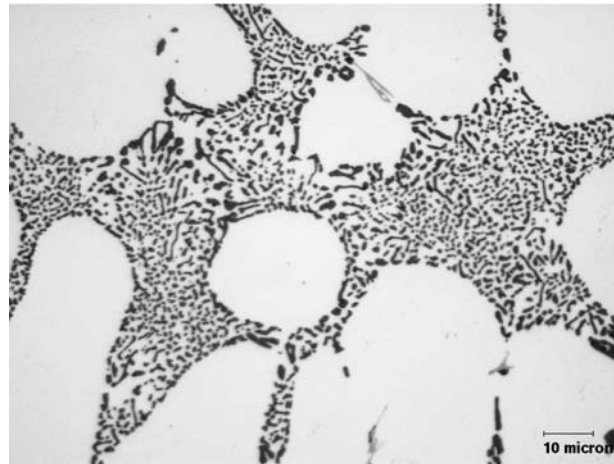

Fig. 3—Schematic of the Jominy end quench apparatus.

electronic microscope and optical microscope. The shape and size of silicon particles reveal the extent of solutionizing. Solutionizing for long periods modifies the morphology of the eutectic silicon. The rounding of silicon particles can effectively improve the ductility and fatigue properties of the alloy. From Figure 4, both the spheroidization of acicular silicon and the coarsening of small silicon particles are observed by comparing the silicon morphology before and after the solutionizing treatment. More spherical particles are seen in the as-solutionized sample that was solutionized at 540 °C for 4 hours. The average equivalent diameter of Si particles in an as-solutionized A356 Jominy end quench bar is 3.6 μm. The Fe-containing π/β phases can also be seen on the cell/grain boundaries. These iron-rich phases are detrimental to the alloy and require a much longer solutionizing time to be dissolved. In most cases, complete dissolution of iron-containing phases is not observed.^[23]

B. Quench Factor Modeling

Both the thermal history of an alloy and the mechanical properties that result from specific quenching rates need to be obtained for quench factor modeling.



(a) as-cast



(b) as-solutionized

Fig. 4—Microstructure of (a) as-cast and (b) as-solutionized cast aluminum alloy A356.

Table II. Distance from the Quench End Where Experimental Data was Collected

Millimeter	3.20	6.40	9.50	12.7	15.8	22.2	31.7	38.1	50.8	63.5
Inch ($\times 1/16$)	2	4	6	8	10	14	20	24	32	40

The thermal history of cast aluminum alloy A356 was obtained by measuring the time-temperature data during quenching with K-type thermocouples at selected locations of a Jominy end quench bar after the bar was solutionized at 540 °C for 4 hours. Selected locations are given in Table II. The locations are selected to cover a wide range of cooling rates. The time-temperature and cooling rate profiles at ten different locations of a Jominy end quench bar are presented in Figures 5(a) and (b). Due to the nature of axial cooling along the bar, a large variation in cooling rate is observed. At the point of 3.2 mm from the quench end, the maximum cooling rate is approximately 150 °C/s, which is equivalent to water quench. The maximum cooling rate decreases dramatically to about 5 °C/s at 63.5 mm from the quench end, similar to the cooling rate attainable from an air quench. A large range of cooling rates, from the fastest to the slowest, can be attained from quenching a Jominy end quench bar.

Meyer hardness values were obtained from the conversion of Rockwell B hardness values with the relationship established by Tiryakioglu and Campbell.^[22] Two flats, milled down 0.381 mm from the surface, were made on a Jominy end quench bar aged for 6 hours at 165 °C. Rockwell B hardness was measured at the locations where the time-temperature data were collected. The Meyer hardness is plotted with the distance from the quench end in Figure 6. The hardness value ranges from 143 MPa at 3.2 mm from the quench end to 130 MPa at 63.5 mm from the quench end.

The maximum Meyer hardness, \bar{P}_{max} , in Eq. [3] is taken as the value at the quench end because the quench end is subject to the most severe cooling and only limited precipitation is assumed to possibly occur during quenching. To obtain the minimum Meyer hardness \bar{P}_{min} in Eq. [3], a Jominy end quench bar was solutionized at 540 °C for 4 hours in a conventional furnace and transferred to a fluidized bed that was preheated to 540 °C. The heater was turned off and the blower was left on. The test bar cooled slowly in the fluidized bed for about 20 hours to allow the precipitation to approach the equilibrium state. The bar was then quenched in water and subsequently aged at 165 °C for 6 hours in a conventional furnace. Hardness was measured on the cross section of the as-aged specimen. Ten readings were taken and averaged to obtain the minimum hardness used in the quench factor models.

Among the techniques available in the literature for determining the kinetic parameters, multiple linear regression analysis was employed in this article. Instead of minimizing the squares of the difference between the predicted and measured property, as described in the least-squares routine, this method is used to obtain a best linear relationship between a function of experimentally measured properties and calculated quench factors.

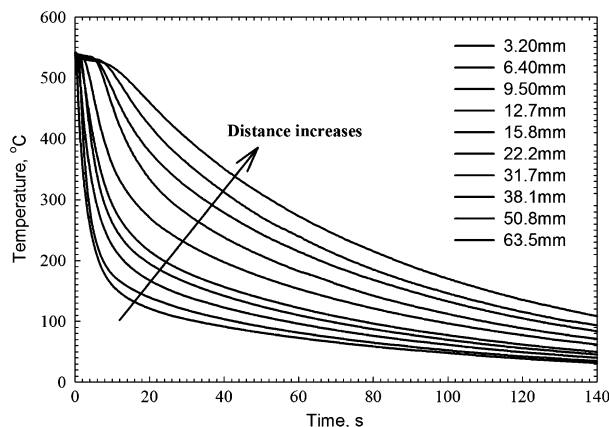

(a) Temperature vs. time

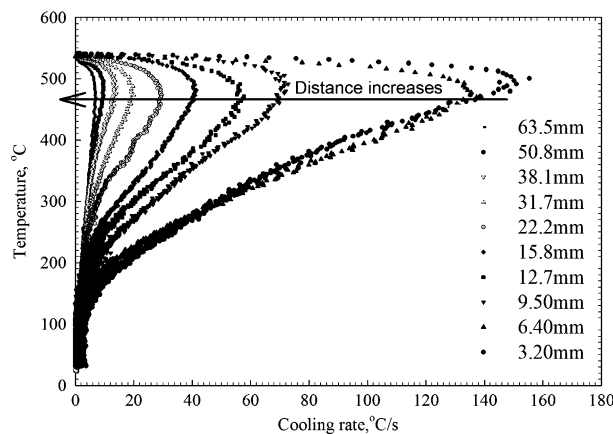

(b) dT/dt vs. temperature

Fig. 5—(a) Cooling curves and (b) cooling rate curves at different locations of a Jominy end quench bar of cast aluminum alloy A356.

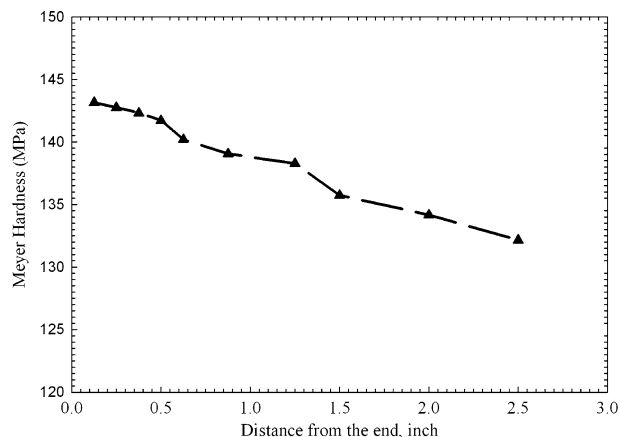

Fig. 6—Meyer hardness along a Jominy end quench bar of cast aluminum alloy A356.

If double natural logarithms are taken on both sides of Eq. [3], the Eq. [7] is generated. Because the relationship between the strength and quench factor in Eq. [3] is valid, the logarithm of fractional Meyer hardness has a linear relationship with $\ln(Q)$, with the intercept being Avrami exponent n , as shown in Eq. [7].

$$\ln \left[\frac{1}{K_1} \ln \left(\frac{\bar{P} - \bar{P}_{\min}}{\bar{P}_{\max} - \bar{P}_{\min}} \right) \right] = n \ln (Q) \quad [7]$$

The left side of the equation can be calculated with the known maximum hardness, minimum hardness, and measured hardness at selected locations of a Jominy end quench bar. Together with experimentally measured quenching data in Figure 5, K constants in Eq. [1] are initially estimated to calculate the quench factors Q using Eq.[2]. The logarithm of fractional Meyer hardness is plotted against $\ln(Q)$ as a scatter plot. The scatter plot is fitted with a linear curve and the coefficient of determination (R^2) for the curve is calculated.^[18] Constants in Eq. [1] are iteratively adjusted until calculated quench factors provide the highest possible coefficient of determination for the plot and the fitted linear curve passes through the origin (or the intercept is very close to 0).^[18] An example best-fit curve using Eq. [3] is shown in Figure 7. The kinetic parameters and Avrami exponent obtained from multiple linear regression analysis are presented in Table III. Constants for the improved quench factor model in Eq. [4] are obtained with the same analysis and are presented in Table III.

With estimated kinetic parameters in Table III, critical times at different temperatures were calculated using Eq. [1] and plotted as a function of temperature for both original and improved quench factor models, as shown in Figure 8. These two TTP curves correspond to 0.5 pct precipitation of a secondary phase in cast aluminum alloy A356.

C. Experimental Verification

Experimental verification was performed using a cast aluminum alloy A356 engine cylinder head, which was cast from the lost foam casting process. Sixty-four engine heads were placed in a quench load and two layers (2×32) in a continuous furnace.^[19] One of the engine heads was instrumented with K-type thermocouples to record the time-temperature data during the quenching process. One engine head was selected for the purpose of mechanical testing and metallographic investigation. The rest of the engine cylinder heads were used as dummies to study the effect of the racking pattern.

Engine heads were solutionized at 538 °C for 5 hours in a continuous furnace and quenched in agitated water at 76 °C. As shown in Figure 9, K-type thermocouples were instrumented at the selected nine locations of a five-cylinder engine head and time-temperature data were collected at these locations during quenching. As-quenched cylinder heads were aged at 160 °C for 4 hours.

Two specimens were removed from the locations where thermocouples 7 and 8 were located in the engine head. Rockwell B hardness measurements were taken near the spot where the thermocouple tips were attached using a Wilson hardness tester model 3JR, S/N 10661. The results are shown in Table IV. Using the time-temperature data collected at the corresponding two locations, the Meyer hardness was predicted with kinetic parameters given in Table III and converted to Rockwell B hardness. The predicted hardness data were compared with that experimentally measured. The results are shown in Table IV. The predicted hardness

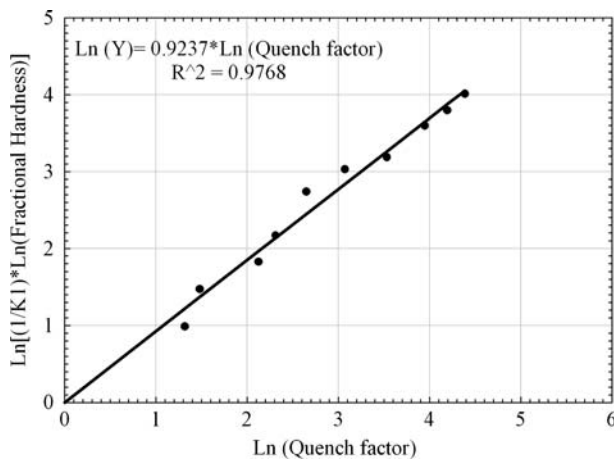

Fig. 7—An example best-fit curve for quench factor analysis of cast aluminum alloy A356.

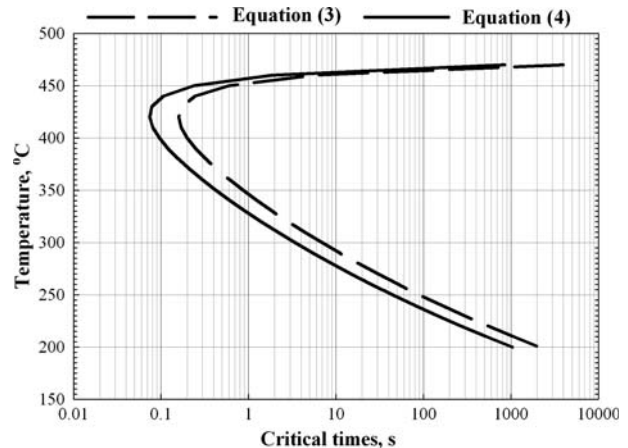

Fig. 8—TTP curves for cast aluminum alloy A356 (Eq. [3] corresponds to the original quench factor model; Eq. [4] corresponds to the improved quench factor model).

Table III. Precipitation Kinetic Parameters of Cast Aluminum Alloy A356 during Quenching

Equation	K_1	K_2	K_3 (J/mol)	K_4 (K)	K_5 (J/mol)	Avrami Exponent, n
[3]	-0.00513	1.27×10^{-9}	60	764	131,000	0.92
[4]	-0.00513	6.41×10^{-10}	56	764	131,000	0.92

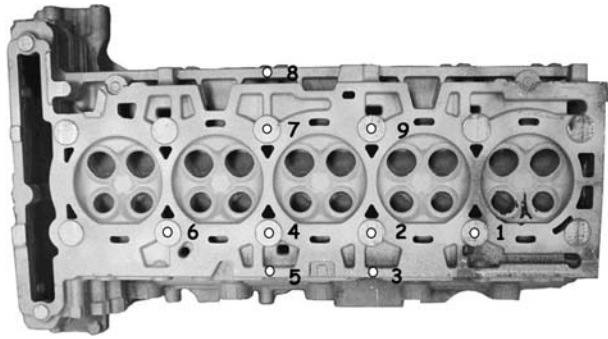

Fig. 9—Cast aluminum A356 engine head instrumented with K-type thermocouples.

Table IV. Predicted and Measured Hardness of a Cast A356 Engine Head

Hardness	Location 7	Location 8
Measured hardness	58.5 (± 0.8)	59.4 (± 1.0)
Predicted hardness (Eq. [3])	59.0	59.5
Predicted hardness (Eq. [4])	58.9	59.3

agreed well with the experimental result. These results have also been presented elsewhere.^[19]

VI. SUMMARY

A methodology to predict the effects of quenching rates on the mechanical properties of cast aluminum alloys was described in this study. Based on this methodology, kinetic parameters during quenching for cast aluminum alloy A356 were estimated with experimentally measured quenching rates and the Meyer hardness along a Jominy end quench bar. The TTP curves for cast aluminum alloy A356 were generated with estimated kinetic parameters. Experimental verification was performed on a cast aluminum alloy A356 five-cylinder engine head. The hardness was predicted using quench factor analysis and compared with experimental results. The predicted hardness agreed well with that experimentally measured. This methodology requires little experimental effort and can also be used to experimentally estimate the kinetic parameters during quenching for other heat-treatable aluminum alloys.

ACKNOWLEDGMENT

The support of the Department of Energy (DOE) is gratefully acknowledged (Grant No. DE-FC36-01ID14197).

REFERENCES

1. J.T. Staley and M. Tiryakioglu: *Proc. Materials Solutions Conf.*, ASM International, Materials Park, OH 44073, USA, Nov 2001, pp. 6–15.
2. C.E. Bates and G.E. Totten: *Proc. 1st Int. Conf. on Quenching & Control of Distortion*, ASM International, Materials Park, OH 44073, USA, 1992, pp. 33–39.
3. R.C. Dorward: *J. Mater. Process. Technol.*, 1997, vol. 66, pp. 25–29.
4. D.S. MacKenzie: Ph.D. Dissertation, University of Missouri–Rolla, Rolla, MO, 2000, pp. 94–100.
5. D.S. MacKenzie and J.W. Newkirk: *Proc. 8th Sem. IFHTSE*, 2001, p. 119.
6. W.L. Fink and L.A. Willey: *Trans. Am. Inst. Mining Metall. Eng.*, 1947, vol. 175, pp. 414–27.
7. G.P. Dolan, J.S. Robinson, and A.J. Morris: *Proc. Materials Solutions Conf.*, ASM International, Materials Park, OH 44073, USA, Nov 2001, pp. 213–18.
8. G.P. Dolan and J.S. Robinson: *J. Mater. Process. Technol.*, 2004, vols. 346–351, pp. 153–54.
9. J.T. Staley: *Mater. Sci. Technol.*, 1987, vol. 3, pp. 923–35.
10. J.D. Bernardin and I. Mudawar: *Int. J. Heat Mass Transfer*, 1995, vol. 38, pp. 863–73.
11. H.S. Fong: *J. Mater. Process. Technol.*, 1993, vol. 38, pp. 221–26.
12. G.T. Brown, K. Sachs, and T.B. Smith: *Metallurgia Met. Forming*, 1976, pp. 239–47.
13. G.E. Totten and D.S. Mackenzie: *Mater. Sci. Forum*, 2000, vols. 331–337, pp. 589–94.
14. J.W. Newkirk and D.S. MacKenzie: *J. Mater. Eng. Performance*, 2000, vol. 9, pp. 408–15.
15. J.W. Newkirk and S. Mehta: *Heat Treating*, 2000, vol. 2, pp. 1094–1100.
16. D.S. MacKenzie and J.W. Newkirk: *Proc. 8th Sem. IFHTSE*, ASM International, Materials Park, OH 44073, USA, 2001, p. 139.
17. R.J. Flynn: *Advances in the Metallurgy of Aluminum Alloys*, ASM International, Materials Park, OH, 44073, USA, 2001, pp. 183–88.
18. P.A. Rometsch and G.B. Schaffer: *Int. J. Cast Met. Res.*, 2000, vol. 12, pp. 431–39.
19. M. Maniruzzaman: Worcester Polytechnic Institute, Worcester, MA, unpublished research, 2005.
20. P.A. Rometsch, M.J. Starink, and P.J. Gregson: *Mater. Sci. Eng. A*, 2003, vol. 339, pp. 255–64.
21. J.T. Staley, R.D. Doherty, and A.P. Jaworski: *Metall. Trans. A*, 1993, vol. 24A, pp. 2417–27.
22. M. Tiryakioglu and J. Campbell: *Mater. Sci. Eng. A*, 2003, vol. 361, pp. 232–39.
23. S.K. Chaudhury, L. Wang, and D. Apelian: *Trans. AFS*, 2004, pp. 289–304.